



● Patents

- ZL 99 2 48179.1 (China)
- US 6299225 B1 (U.S.A.)
- GB2355753 (UK)
- 166716 (Taiwan)

● Statement

The GK300 series electric strike is dual voltage which the locks supplies high and low voltage electrical power and it can be used for either 12 or 24 VDC operation, and the Gk300 series electric strike is easy changeable between fail-safe and fail-secure in the field. Therefore, with special designed mechanism, this electric strike is ideally suited and meets the varying needs of our customers.

The GK-300 series electric strikes (ANSI-sized) are designed for used with lockset (ex. spring latch), Max. latch throw 15mm for inswing doors. The units are design for using with most hollow metal frames and aluminum frames. Stainless steel plate ensures strength and long life.

● Specifications

- Operating Voltage: 12/24VDC
- Current Draw: 0.28 A/12VDC; 0.14 A/24 VDC (at temperature 20°C)
- Operating Temperature: -10°C~45°C
- Humidity: 0~95% non-condensing.
- 2000 LBS jaw strength pull testing.
- Material: Stainless Steel Faceplate, Aluminum Alloy Case
- Tested to 1,000,000 cycles.
- Net Weight: 380 g

● Optional Accessory

Lip extension brackets for the wide jamb.

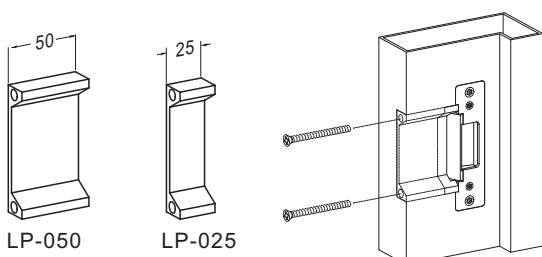

● Dimension

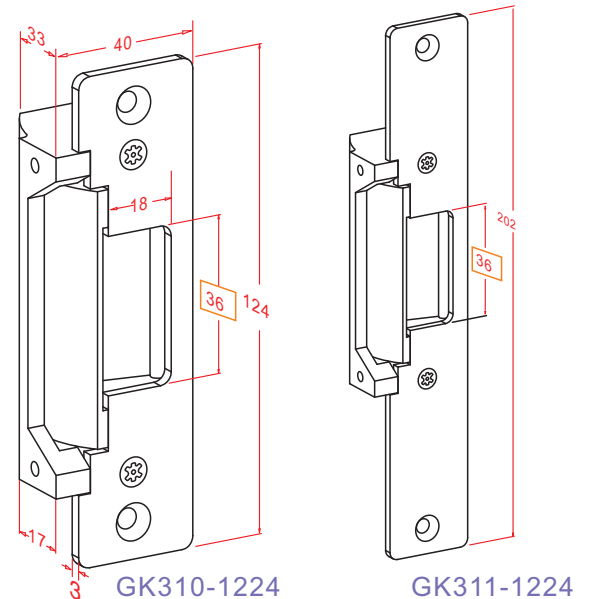

● What's Latch Bolt Lock ?

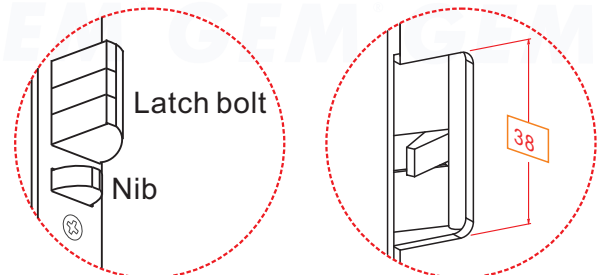

A latch bolt lock is a lock comprising a latch bolt and a nib. When the door is closed, the nib makes the latch a dead bolt. The latch bolt locks into the strike keeper of the door frame to make sure that it is closed. Latch-bolt locks are available in **GK-310** and **GK-311** model.

● Version Changeable

The GK-300 electric s trike can easily be changed between fail-safe and fail-secure modes. This unique design enables distributors to reduce inventory and still meet varying needs and requirements of end users.

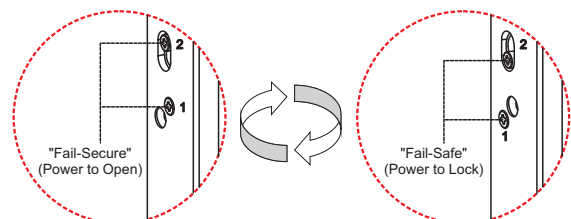

GIANNI INDUSTRIES, INC.

Model Comparison List

Model	Door frame		Application Lockset	Installation	Optional Accessory
GK310-1224	Hollow metal Frames		Latch bolt lock	Mortise Mount	LP-025, LP-050
GK311-1224	Wood Frames		Latch bolt lock	Mortise Mount	LP-025, LP-050

Voltage switchable

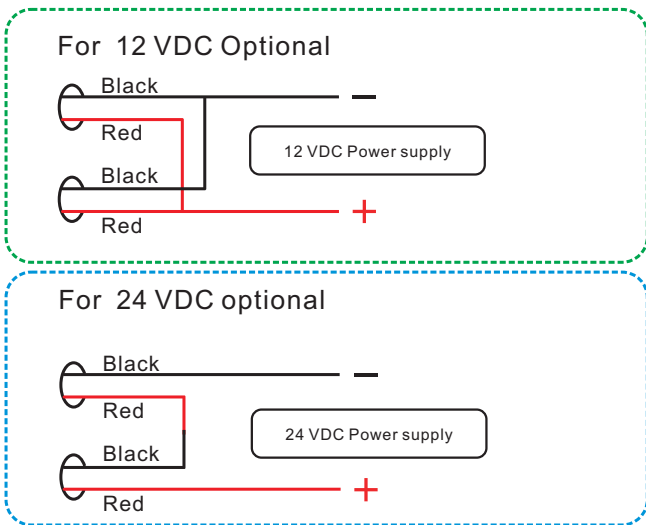

GK350 Surface Mount

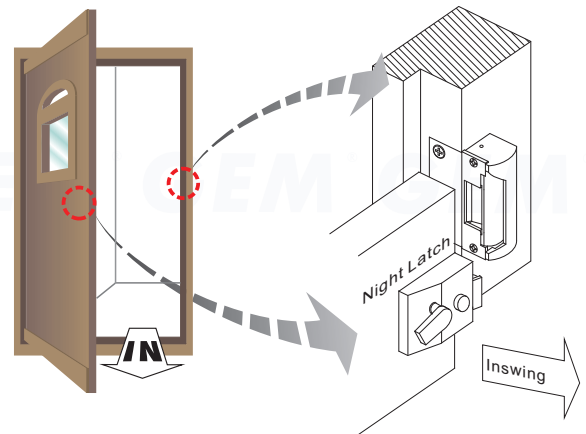

GK301, 311 Wood Frames Mortise Mount

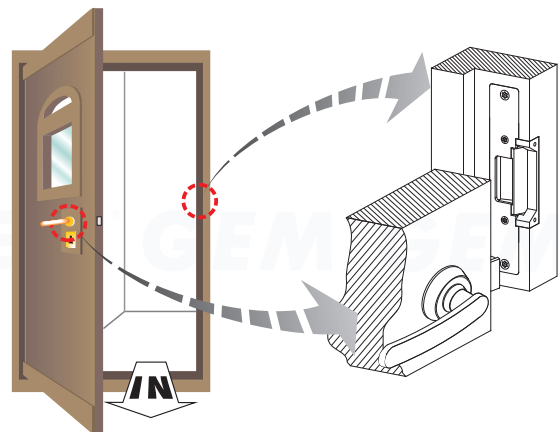

Long life solenoids

Special solenoids designed for strength and long life guarantee a lifetime of at least 1,000,000 cycles.

CSIRO Fire-resistance Certificate

This product, its materials and assemblies have been proven to be fire resistant in accordance with the test procedures of Sponsored Investigation FSV 0609 and the terms of clause 4.1 of Australian Standard 1905, Part 1-1997.

Warranty

The product is warranted against defects in material and workmanship while used in normal service for a period of 3 years from the date of sale to the original customer. The GEM policy is one of continual development and improvement; therefore GEM reserves the right to change specifications without notice.

GIANNI INDUSTRIES, INC.