

aperta

APKITKPG | COLOUR VIDEO DOOR ENTRY SYSTEM



USER MANUAL



www.espuk.com



Contents

System Components	3
Installation	4
System Connections Example 1.....	5
System Connections Example 2.....	6
Lock Connections Example 1 & 2.....	7
Door Station Programming Guide	8
User Guide	10
Monitor Overview.....	11
Setting Monitor as Master or Slave (Default Master).....	12
Accessing Monitor Functions.....	13
Accessing Monitor Adjustments	14
Installer's Guide	15

System Cabling

All system cabling (excluding mains 240vAC supply) has been tested with Cat5E UTP PVC cable.



Part Number - A8NFORCE5EUTP

Find this product online:
elandcables.com | Cables & Accessories | LAN Cable | Cat 5E UTP PVC Cable





System Components



Door Station



Monitor



System Power Supply

Optional Accessories



EVBPSBB
Lock Power Supply



EV-EXIT
Push To Release



EV-EBG
Emergency Release



EV-ML-250/500XT
Electro-magnetic Lock



ENTERD
Electric Lock





Installation



Site the door station a recommended 1.5 meters from the ground, or to suit application.

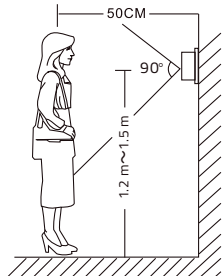

The camera needs to point in the direction of where a visitor will stand during operation.

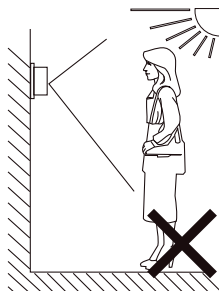

Avoid areas of high sunlight and noise levels.

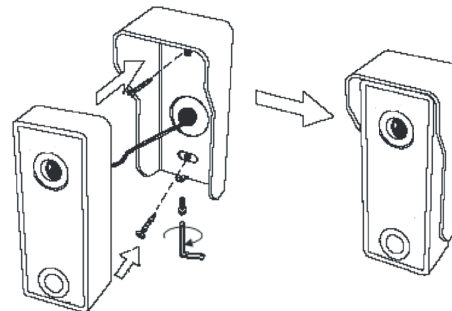

Surface mount the sunshield of the door station and connect the system cabling. Mount the camera to the sunshield by fixing with the supplied hex screw.

Site the indoor monitor to suit application.

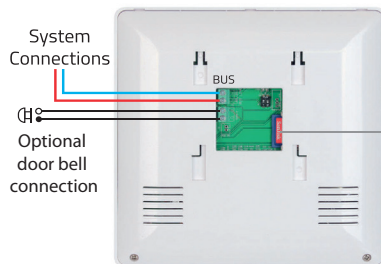

System Connections

Optional door bell connection

SD card slot (32GB Max.)
Records visitor images

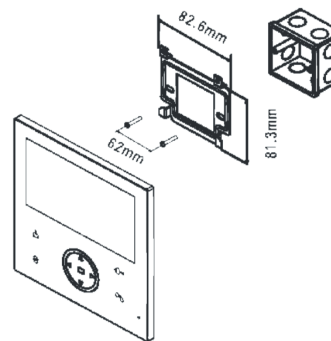

Surface mount the bracket of the monitor or if required onto a 1-gang mount box (not supplied). Make the system connections to the back of the monitor and then slide the monitor onto the bracket using the hooks to hold firmly in place.



System Connections Example 1

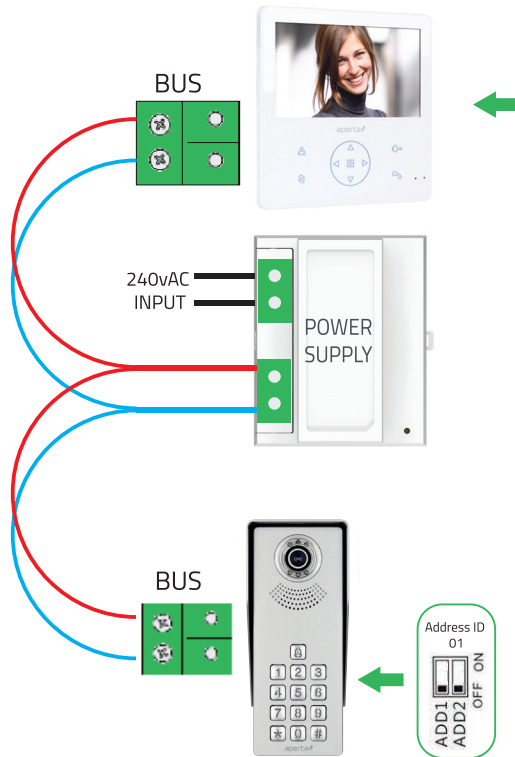

K1
ON
1

The last monitor on the system line has the rear 'K1' switched ON

Total cable run should not exceed 150 meters between door station and monitor

Power supply to be with-in 100 meters of monitor

No cable or connection polarity

Ensure the Address ID switches are both set to OFF

System Connections Example 2

The system power supply can support up to 5 devices

Total cable run should not exceed 150 meters between door station and monitor

Power supply to be with-in 100 meters of monitor

No cable or connection polarity



1. The last monitor on the system line has the rear 'K1' switched ON. All other monitors 'K1' switch to OFF

2. Please review page 12 to set monitor to MASTER or SLAVE.

3. If different types of Monitor /handset are being used on the same system, please refer to the supplied instructions to adjust Master/ Slave settings.

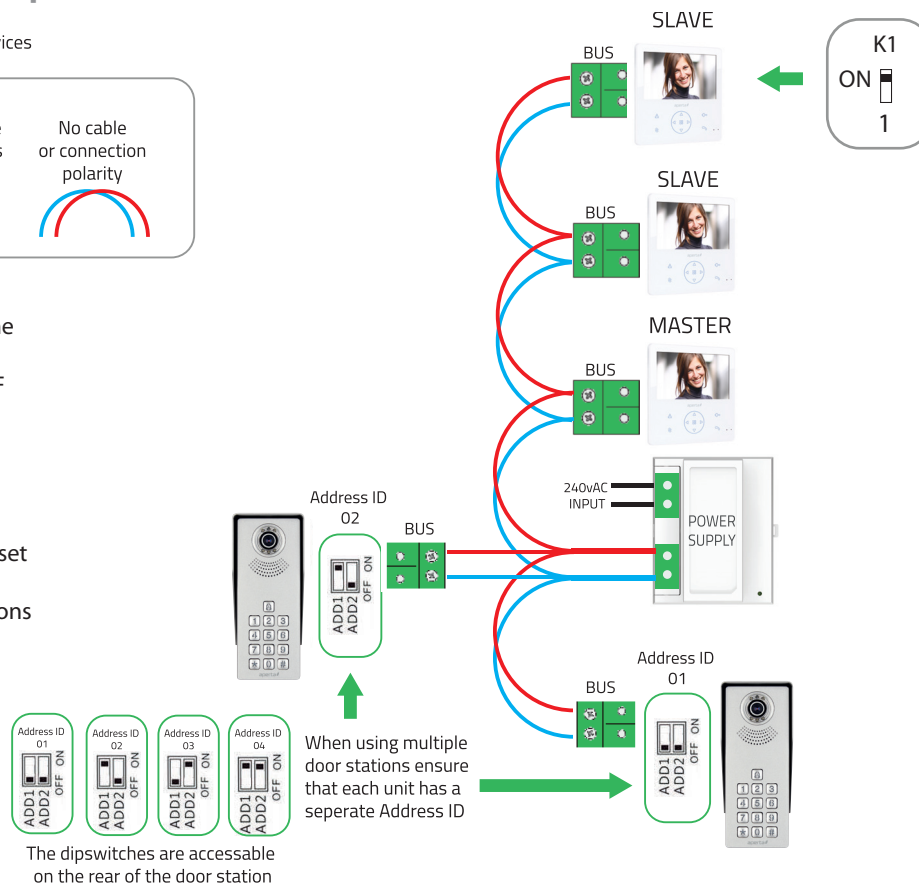



Lock Connections Example 1

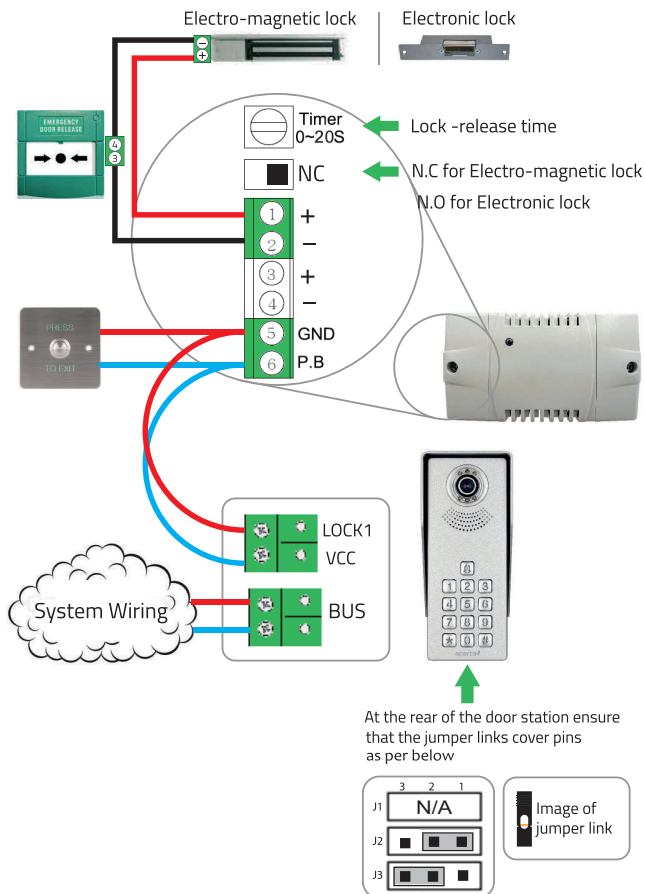

Lock Connections Example 2

- The jumpers on the rear of the door station offer different types of release modes for alternative applications dependent on the jumper link settings. LOCK1 options;
- The door station has a secondary switch. LOCK2 options;

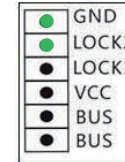
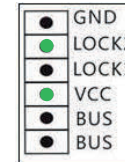
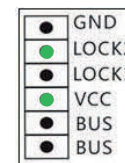
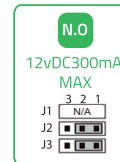
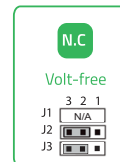
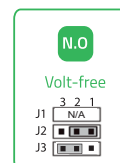
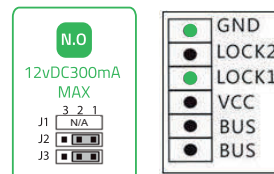
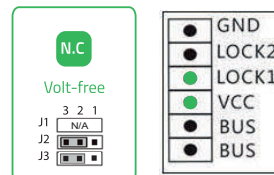
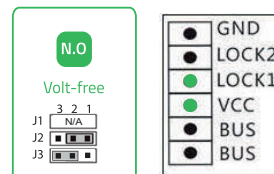

- Please refer to the operation guide for release instructions

Door Station Programming Guide

Entering Administration Mode

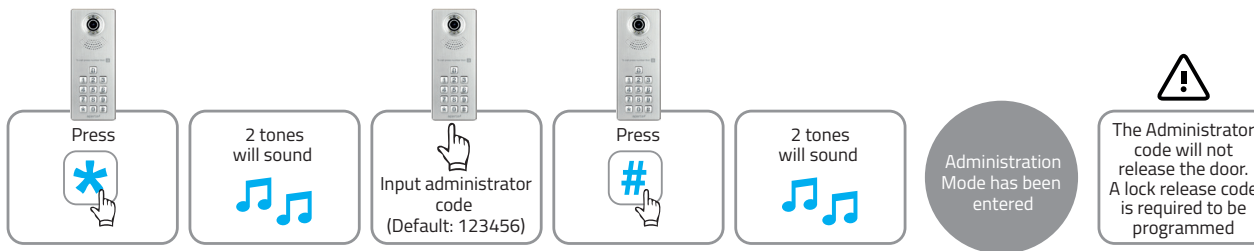

Setting a lock release code

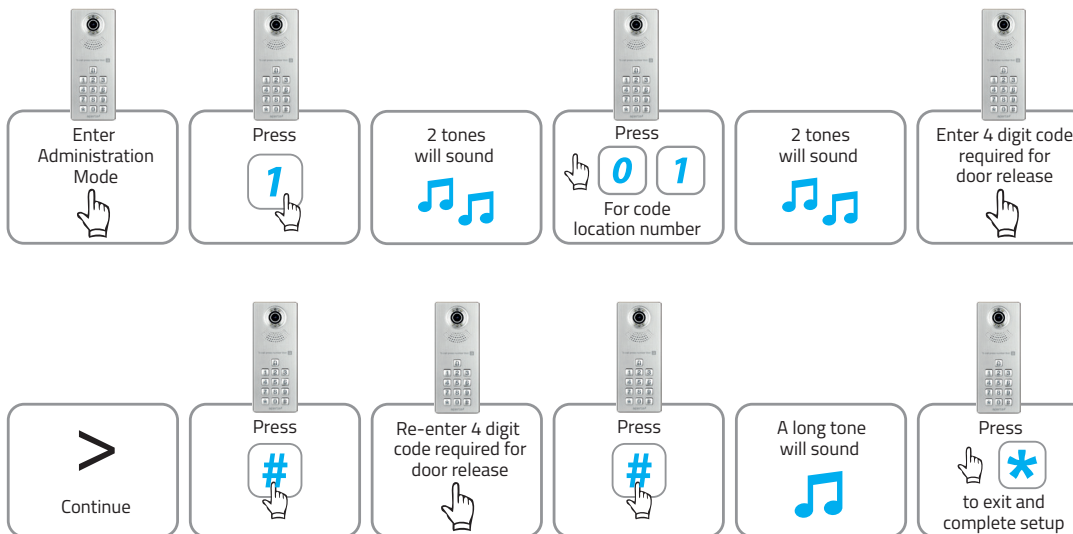



Deleting a lock release code

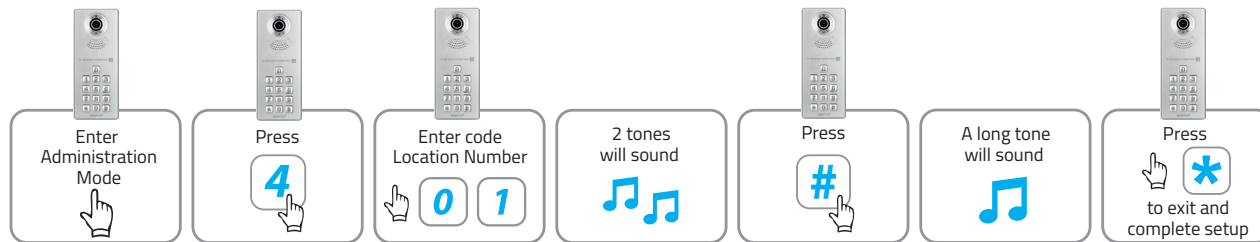

Changing the Administrator code



User Guide

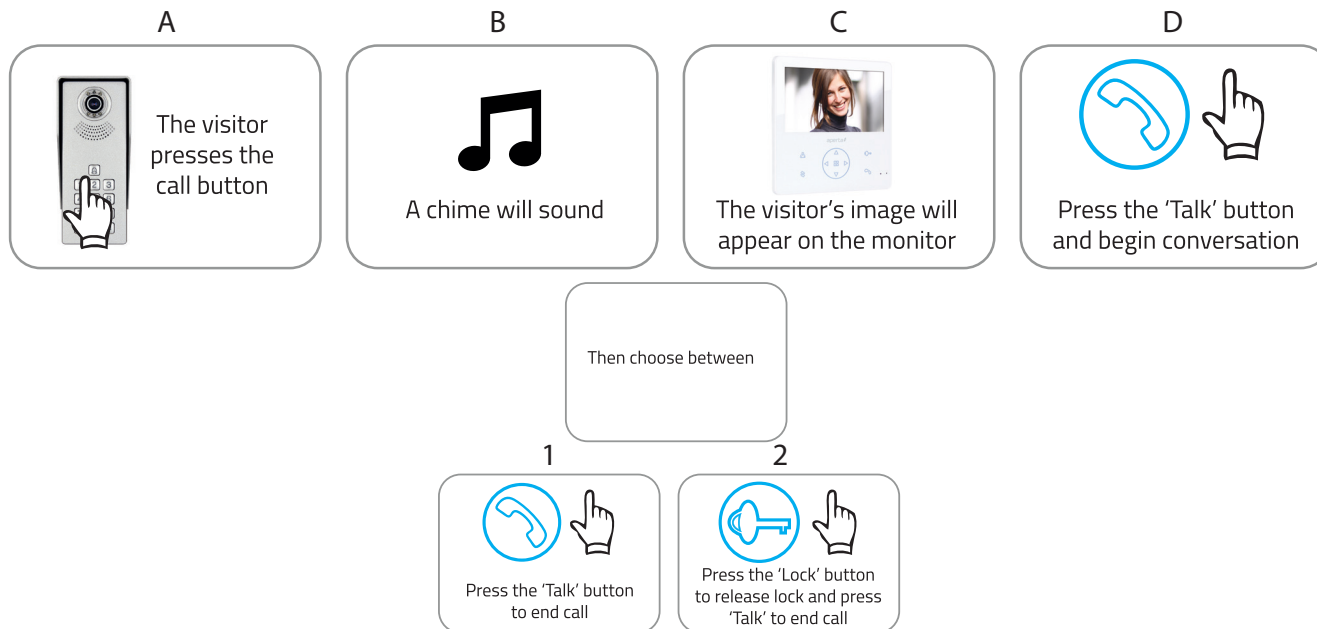

Using the lock release code





Monitor Overview

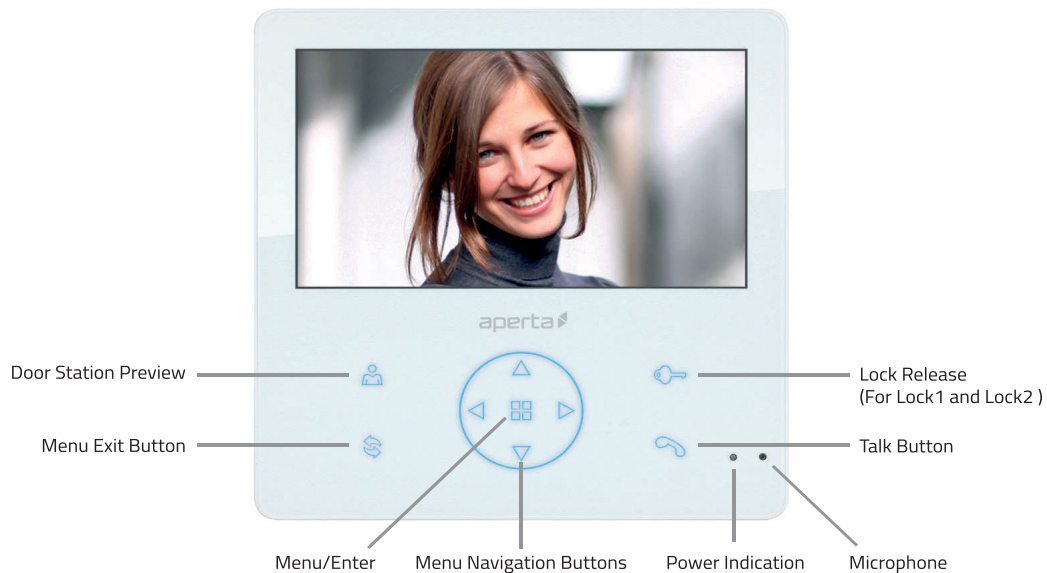

The following monitor instructions are designed to be a quick start guide alongside the informative general user interface (GUI) . The instructions are not exhaustive and are designed to lead the user quickly to the most often required aspects of the unit.



Setting Monitor as Master or Slave (Default Master)

1. In standby mode press the menu button and the time screen will display.



2. Press and hold the Key for 5 seconds and the Installation setup screen will display.



Installation setup	
Master	[8000], Slaver1~3 [8001~ 8003]
Local address set as	1~32 [8201~8232]
Unlock time set	1~9S [8021~8029]
Guard unit on	[8004], guard unit off [8005]
Panel on as slaver call	[8006], panel off [8007]
Unlock mode 0	[8010], mode 1 [8011]
Bypass enable	[8016], disable [8017]

3. Press the menu button and use the right arrow to toggle between Master and Slave position.

Master [8000], Slaver1~3 [8001~ 8003]

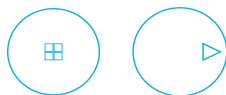

4. Press the menu button to save setting, and press the exit symbol twice. After 10 seconds the monitor returns back to standby.



Accessing Monitor Functions

1. In standby mode press the menu button and the time screen will display.



2. Press the menu button whilst on the time screen and the main menu screen will display.

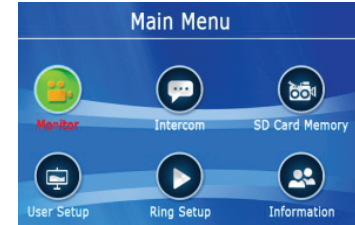

PREVIEW option for all system door stations.



INTERNAL CALL options

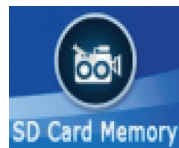

RECORDING & VIEWING options can be found in the 'SD Card Memory' menu



DATE and TIME settings can be found in the 'User Setup' option. Also includes 'ring mode' for selective ringing times.

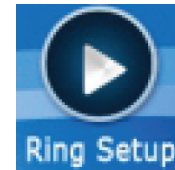

RING TONE

Options for incoming, internal and optional door bell tone selections.



Accessing Monitor Adjustments

1. In standby mode press the preview button and the door station's image will display.



2. During the preview press the menu button and the adjustment controls will appear.

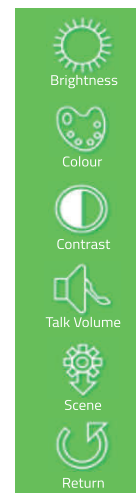



Installer's Guide

Master / Slave Setting

When using multiple monitors on 1 system;
Only the 1 handset set as the MASTER will display an image when the door station is activated.
All other monitors will ring, and will display the image once the 'Talk' button is pressed.

In the event of no video or audio signals coming from the monitor, or if the call button or audio cannot be activated on the door station, check the following;

- A That the system is powered sufficiently.
- B Each monitor needs to be set to a MASTER or SLAVE position
- C All system cabling is secured and properly connected.
- D All system cabling is clear of breaks or short circuits.
- E Bench test the system if the issue cannot be found.

In the event of a lock release issue, check the following;

- A The user instructions and operation of the monitor has been understood.
- B That the lock is powered sufficiently.
- C All system cabling is secured and properly connected.
- D All system cabling is clear of breaks or short circuits.
- E On the rear of the door station, ensure the lock output is switching when activated by the monitor.



Elite Security Products
Unit 7, Target Park, Shawbank Rd
Lakeside, Redditch B98 8YN



Telephone: 01527 51 51 50
Fax: 01527 51 51 43
email: info@espuk.com

E&OE - Errors and omissions excepted. D17

www.espuk.com

