

BoostMaster

IP65 Time Delay Switch

Model: DS3HD - White



**TIME GUARD**[®]
LIMITED

Installation & Operating Instructions

- L** - MAINS LIVE IN (right hand position of connector)
- SL** - MAINS LIVE OUT (TO EXTERNAL LOAD) (second from right hand position of connector)
-  **EARTH** – Connect any Earth wires to this pin
- N** – NEUTRAL (IN) (fourth from right hand position of connector)
- N** – NEUTRAL (OUT) (fifth from right hand position of connector)
- **NOTE:** Ensure that all screws on the mains connector are tightened adequately.
- Adequately tighten the nuts on the cable entry points on the outside of the box.
- Select the required time delay by using the time delay selector as shown below.
- Screw the front panel back on. Ensure tight fitting for IP compliance
- Switch on mains supply. The unit is now ready for operation.

4. Internal Delay Selection Switches

Four internal DIL switches are available to select 8 time delay settings as shown below.

Please Note: On the DIL switch, switch 1 is not in use



Time (minutes)	Switch 4	Switch 3	Switch 2
2	L	L	L
5	L	L	R
10	L	R	L
30	L	R	R
60	R	L	L
90	R	L	R
120	R	R	L
180	R	R	R



Left = ON

Right = OFF

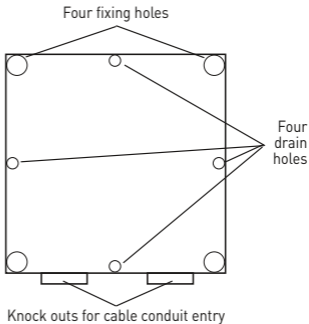
Drain holes positions are shown below. The drain holes must be drilled out using a 5mm drill. Opening the drain hole will reduce the IP rating of the product.



1. Technical Specifications

Conforms to Directives:	73/23/EEC & 89/336/EEC
Operating Voltage:	230V 50Hz
Switching Capacity:	Incandescent: 16A 
	Fluorescent: 16A 
	Resistive: 16A
	Motor: 1hp 
Operating temperature:	-10°C to +40°C
Timing range:	2 minute to 180 minutes in 8 steps
Timing accuracy:	+/- 2%
Enclosure:	Flame-resistant polycarbonate material.
IP rating:	IP 65
Dimensions:	94 mm x 94 mm x 57 mm
Terminals:	Suitable for 1.5mm ² to 4mm ²

3 Year Guarantee

In the unlikely event of this product becoming faulty due to defective material or manufacture within 3 years of the date of purchase, please return it to your supplier in the first year with proof of purchase and it will be replaced free of charge. For years 2 and 3 or any difficulty in the first year telephone the helpline on **020 8450 0515**.

DS3HD IP65 Time Delay Switch

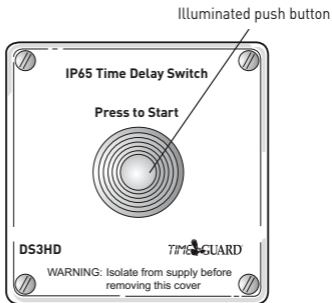

Figure 1 - Front Panel of DS3HD

1. General

The DS3HD is a time delay switch designed to switch on an externally connected load to mains supply when the push button is pressed. It will then automatically switch off the load after a time delay has elapsed. The time delay can be selected by three internal DIL switches to give 8 different time delays. The time delay can be cancelled at any time by pressing the push button again in which case the blue LED will flash and the load will be disconnected after one minute.

2. Functional Description

There is a single blue LED illuminated push button switch on the front panel. When pressed, the DS3HD will function as follows:

- The blue LED will turn off.
- An externally connected load will be switched on for the selected time delay.
- One minute before the end of the time delay, the blue LED will flash.
- At the end of the time delay, the externally connected load will be switched off from mains supply.
- The blue LED will switch permanently on until the push button is pressed again.
- If the push button is pressed when the time delay is still running, the delay will be terminated after 1 minute.
- If the push button is pressed in the last minute of the time delay (when the blue light is flashing) the count down will be reset and the timer will restart the time delay.

3. Mounting and Installation

Warning: Switch off mains electricity before proceeding with installation.

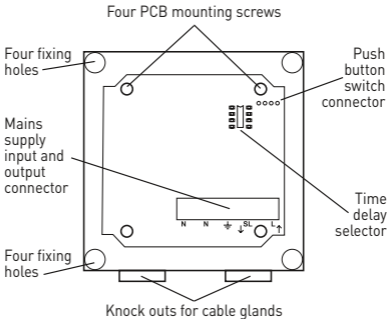

Figure 2 - Internal of DS3HD

IMPORTANT NOTICE:

- This product should be installed in accordance with the current IEE and Wiring Regulations.
- If in doubt consult a qualified electrician.
- Do not use the mains supply connector for wiring continuity. Mains input must be supplied from its own 16 Amp MCB.

- Remove front panel by unscrewing the four fixing screws.
- If necessary, carefully remove the printed circuit board (PCB) by undoing the four PCB mounting screws.
- Remove knockouts at (preferably) the bottom of the box.
- Use appropriate IP65 rated entry conduits to fit M20 knockouts. Ensure tight fitting for IP compliance.
- Fix surface mount box rigidly to a secure surface by using appropriate screws through the four fixing holes.
- Refit the PCB back onto the surface mount box by progressively tightening each of the four PCB mounting screws in turn. **Do not over tighten the screws**
- Ensuring that the mains wires are adequate for the required load cut the cable tails to the appropriate lengths.
- Insert mains wiring through cable conduits.
- Connect the mains wires to the mains connector as follows:

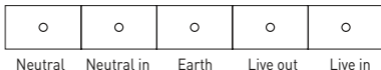

Figure 3 - Mains supply connector

HELPLINE
020 8450 0515

or email helpline@timeguard.com



For a product brochure please contact:

Timeguard Limited.

Victory Park, 400 Edgware Road,
London NW2 6ND

Sales Office: 020 8452 1112
or email csc@timeguard.com

A **theben**[®] Group Company

Designed in the U.K. 67-058-381