



GET plc Key Point 3-17 High Street Potters Bar EN6 5AJ England

t: 01707 601 601 | f: 01707 601 701 | [sales@getplc.com](mailto:sales@getplc.com) | [www.getplc.com/getsmart](http://www.getplc.com/getsmart)

Helpline t: 0121 565 7770 (Monday to Friday 9am-5.30pm )

GET reserve the right to make any changes to the appearance, specification of any product without prior notice to customers.  
All intellectual property rights in this product are proprietary and may not be used without consent. Any enquires should be made to GET plc.

## Smart Wireless Lighting System Installation and User Guide





This product falls within the scope of the Waste Electrical & Electronic Equipment Directive 2002/96 EC. (WEEE)

**NOTE:**  
This product and the batteries in it should not be disposed of with household waste. Please recycle where facilities exist. Check with your local authority for recycling advice.

Should you experience any difficulty with installation of this GET Smart Wireless Lighting System please telephone our Customer Helpline on **0121 565 7770** or visit [www.getplc.com/getsmart](http://www.getplc.com/getsmart) for advice.

GET plc reserves the right to make changes to the appearance, specification of any product without prior notice to customers.

Design registration numbers:

Wireless Remote Controller  
Community registered design No 000224340-0001

Wireless Wall Controller  
Community registered design No 006218359-0001

Ceiling Receiver  
Community registered design No 000382445-0002

Floor Receiver  
Community registered design No 000382445-0001

Introduction to the GET Smart Wireless Lighting System .....	02	Master Controller .....	29
Product Range .....	06	Installing the Controllers .....	31
Additional Products .....	07	Changing the Batteries .....	35
Installing the System .....	08	Frequently Asked Questions .....	38
Safety and Installation Warnings .....	09	Important Information .....	40
Floor Receiver .....	11	Notes .....	41
Ceiling Receiver .....	14		
Installation and Wiring .....	17	<b>Please refer to DVD for suggested ways of using your GET Smart Wireless Lighting System.</b>	
Outdoor Lighting Applications .....	19		
System Set-up .....	20		
Setting the Channels .....	23		
Dimming Mode .....	24		
Setting Scenes .....	25		
Operating a Scene .....	26		
Setting the Function Switches .....	27		

The GET Smart Wireless Lighting System allows you to create lighting ambience and mood scenes in your home or business whilst giving you complete control from stylish fixed and portable control units.

The system works by sending wireless signals from Controllers to wired Receiver units. These receiver units in turn control any light fittings that you connect to them.

The controllers are battery operated and wireless. They communicate with the receivers via radio waves. Controllers can therefore be placed anywhere you like, and can be moved elsewhere at any time.

Most lamps are compatible with the system – all you have to do is connect them to a receiver and follow the programming instructions.

The System has two modes of operation:

Dimming Mode and Scene Mode

### Environment and Installation Considerations

As the system uses radio frequencies, performance is dependant on the installation. Reliable operation in the following environments can be achieved although the effective range will be reduced:

- System installation in metal frame buildings or extensions
- Operation through solid or cavity stone, brick or block walls
- Operation through more than one floor, ceiling, or partition wall
- Locations near radio or television transmitters
- Damp atmospheres e.g. swimming pools, saunas

If erratic operation is experienced moving closer to the receivers can usually be expected to restore correct operation.

## QUESTIONS

## ANSWERS

1. How many Receiver units can I use with my Remote Controller?	There is no limit to the amount of Receivers you can control from your remote.
2. Is there any wattage limitation on the Floor and Ceiling Receivers?	350 watts per Receiver.
3. What is the range of the Controllers?	The typical range of the Controller is 30 metres in open space. Radio waves are affected by conditions such as walls and the weather. See Environment and Installation Considerations on Page 39.
4. Can the Wall Controller be recessed into my existing wall box?	Yes. The Wall Controller is designed to fit into a 16mm wall box.
5. Can I use 2 Controllers to control the same lights?	Yes, in fact there is no limit to the amount of controllers you can use to control the same lights. You just need to set their coding switches to the same setting.
6. Can I expand the Lighting System at a later date?	Yes. The GET Smart Wireless Lighting System can be expanded at any time.
7. How long will the batteries in the Controller last?	This depends on the frequency of use. However based on an average amount of use the batteries should last approximately 2 years.
8. How will I know when my batteries need changing?	The right hand LED on the Controller will flash every time one of the buttons is pressed.
9. Can I use Fluorescent tube lighting with the system?	No, fluorescent lamps are not compatible with the system
10. What type of lamps can I use with the system?	The GET Smart Wireless Lighting System can be used with a wide range of lamp types. See page 6 for details.
11. If my neighbours also has a GET Smart Wireless Lighting System will there be any interference problems?	No. The system has 256 different house codes, therefore you can set your own unique code to prevent interference problems.
12. What standards does the system meet?	BS EN 60669-2-1
13. Will I need to reprogram my system in the event of a power cut, or if the batteries in my Controller go flat?	No, your settings are stored in a memory that does not require constant power, therefore a loss of power will not affect your system.
14. Can I use the Wireless Lighting System with other electrical products?	No, the system is designed only to be used with lighting products.

## Dimming Mode

In Dimming Mode, the Controller acts as a 4 channel dimmer – e.g. pressing Button 1 turns the lights connected to Button 1 on and off (see diagram) and these lights can then be dimmed by using the up and down keys. The same applies for Buttons 2, 3 and 4.

Centre Button Operation – When the Controller centre button is pressed, all channels (and lights connected to those channels) will turn on and off together. They can then be dimmed up or down, as one, simply by using the up and down keys.

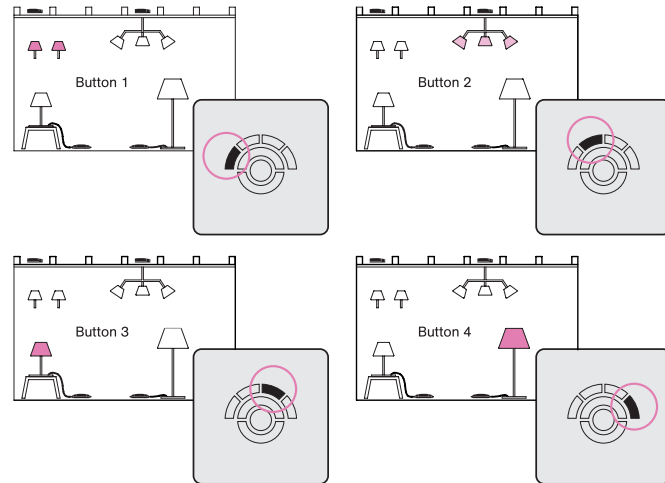

### Scene Mode

In Scene Mode you can set and recall up to 4 lighting scenes per Controller.

Once the scenes have been set, pressing Button 1 turns Scene 1 on and off (see diagram). Pressing Button 2 turns Scene 2 on and off (see diagram). The same applies for Scenes 3 and 4.

Once selected, a scene can be dimmed by pressing the up and down arrow keys on the Controller.

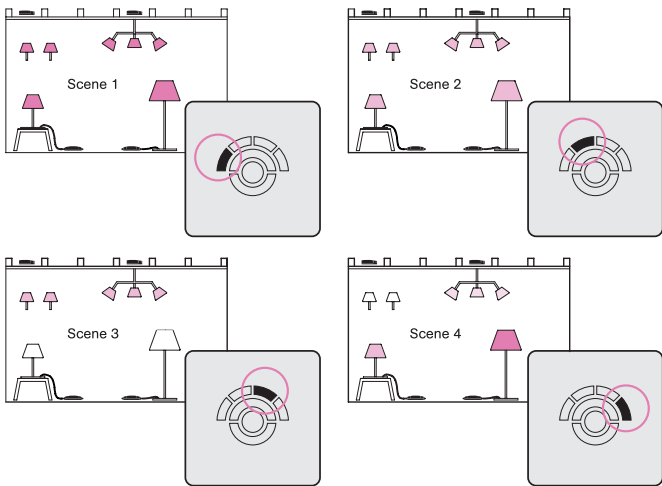

### Wireless Remote Controller – Battery Change

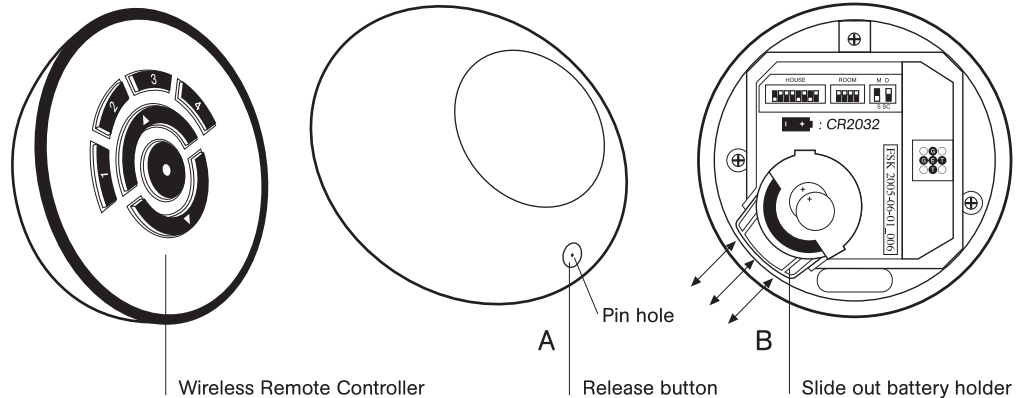

D: Replace with two new CR2032 button cell batteries fitting them with the positive (+) symbol facing upwards. Try not to touch the contact faces of the batteries as this could cause a malfunction. Slide the battery holder back in to the module casing. Ensure you replace the control module with the 'TOP' marking uppermost. Refit the faceplate.

### Wireless Remote Controller

Replacement Batteries 2 x CR2032

- A: To change the batteries in the Wireless Remote Controller press in the button located at the base of the hand set and remove the cover, this exposes the battery holder.
- B: Slide out the holder and remove the discharged batteries by inverting the holder. Replace with two new CR 2032 button cell batteries, fitting with the positive (+) symbol upwards. Don't touch the battery surface. Slide the battery holder into the Controller casing.\* Replace the cover by clipping the cover over the holding pegs at the rear and snapping the front clasp back together.

\* Ensure that the 'TOP' marking on the cover align to the corresponding (TOP) marking on the control module.

### Master Controller Mode

Any Controller can be made into a Master Controller (see page 29).

Master Mode allows you to control up to 4 Room Controllers from one Master Controller, e.g. control whole house lighting from one Controller.

Once programmed, pressing Button 1 on the Master Controller will turn Scene 1 on and off in Room 1, pressing Button 2 on the Master Controller will turn Scene 1 on and off in Room 2 etc. Pressing the centre button turns on/off scene 1 in all Rooms (see diagram).

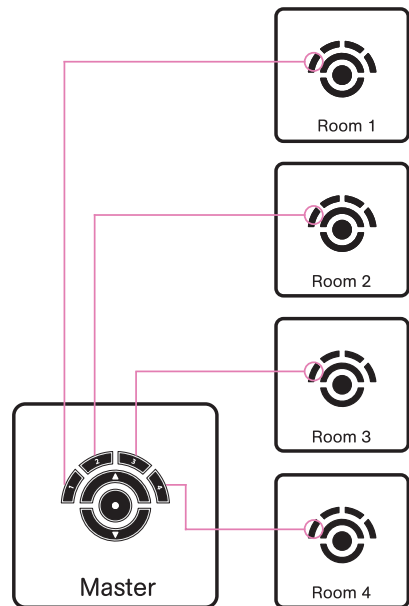

## Product Range

### Wireless Wall Controller (GHAWT)

- + Stainless steel face plate
- + Wireless Wall Control module with 2 fixing options:
  - Grid Frame – to flush/recess mount the Wall Controller in a standard wall box
  - Pattress box – to surface mount the Wall Controller
- + Wireless transmission range approx. 30 metres

### Wireless Remote Controller (GHAPT)

- + Stainless steel face plate
- + Location bracket supplied for wall mounting
- + Wireless transmission range approx. 30 metres

### Ceiling Receiver (GHACR)

- + Maximum load 350W/VA

### Floor Receiver (GHAFR)

- + 1 metre cable (approx.) and 13 Amp plug (fused 5 Amps)
- + Maximum load 350W/VA

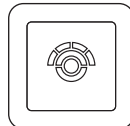

Face Plate

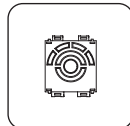

Wall Control Module

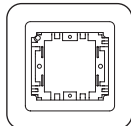

Grid Frame

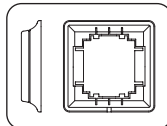

Pattress



Remote Controller

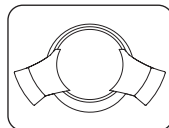

Wall Bracket

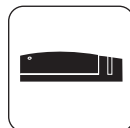

Ceiling Receiver

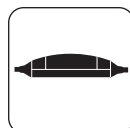

Floor Receiver

## Changing the Batteries

### Wireless Wall Controller

Replacement Batteries 2 x CR2032

Remove the control module from either the surface mounting pattress box or the flush mounted grid plate.

A: Unclip the face plate from the backbox or gridframe.

B: Remove the control module, press the top two clips inwards and ease out the module.

C: The battery compartment is on the back of the module, slide out the battery holder from the module casing and invert to release the discharged batteries.

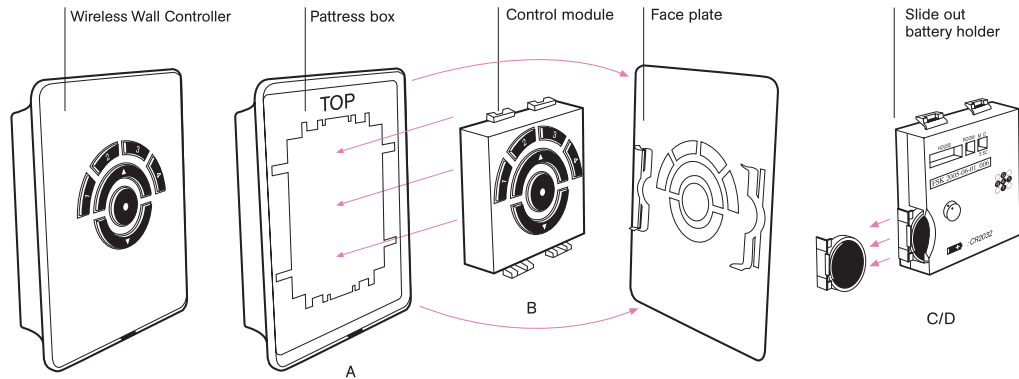

## Remote Controller

Whilst designed for portable use, the Remote Controller can be wall mounted using the bracket supplied.

To fix the wall bracket, carry out the following process.

- a) Pull apart the two sections of the wall bracket. These are held together by a 'snap fit'. They are designed to pull apart. (This acts as a safety feature when they are on the wall).

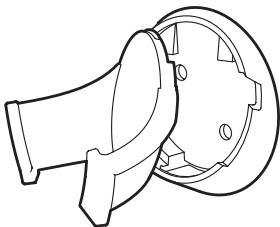

- b) Select where you wish to mount the wall bracket.
- c) Check to ensure that there are no cables or pipes hidden beneath the intended mounting position using a suitable wire and pipe detector.
- d) Holding the rear section of the bracket against the wall, mark the desired position of the holes on the wall.
- e) Drill holes and fit wall plugs as necessary to suit your wall type.
- f) Screw the rear section of the bracket to the wall.
- g) Click the front section of the bracket onto the rear.

## Additional Products

Using the alternative finished face plates you can match the GET Smart Wireless Lighting System to the comprehensive range of Ultimate Screwless Flat Plate wiring accessories.

The following front plates are also available for use with the GET Smart Wireless Lighting System:

- + GHAFPN  
Black nickel – 1 gang face plate
- + GHAFPBZ  
Bronze – 1 gang face plate
- + GHAFPPN  
Pearl nickel – 1 gang face plate
- + GHAFPPC  
Polished chrome – 1 gang face plate
- + GHAFPPB  
Polished brass – 1 gang face plate
- + GHAFPPW  
White metal – 1 gang face plate
- + GHAFSS  
Stainless steel – 1 gang face plate

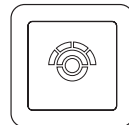

**Dimensions: 88mm x 88mm**

2 Gang plates are also available in the various finishes. These are ideal for retro-fitting into a 2 gang wall box, e.g. where you are replacing a 4 gang dimmer. These plates come complete with grid mounting frame.

- + GHA2GFPBN  
Black nickel – 2 gang face plate
- + GHA2GFPBZ  
Bronze – 2 gang face plate
- + GHA2GFPPN  
Pearl nickel – 2 gang face plate
- + GHA2GFPPC  
Polished chrome – 2 gang face plate
- + GHA2GFPPB  
Polished brass – 2 gang face plate
- + GHA2GFPPW  
White metal – 2 gang face plate
- + GHA2GFSS  
Stainless steel – 2 gang face plate

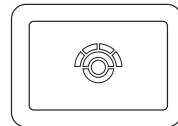

**Dimensions: 88mm x 148mm**

Once you have decided which lights you want to control it is time to start installing the system.

You should install one room at a time. Any light that you want to control with the system will need to be connected to a Receiver. The Controller(s) send signals to the Receiver(s) and these in turn control the lights attached to them.

There are 2 different types of Receiver:

**Floor** – These should be connected to portable types of lighting, e.g. free-standing lamps, table lamps, desk lamps and up-lighters.

**Ceiling** – These should be used for fixed lighting (e.g. ceiling lights, down-lighters and wall lights) and are ideal for using in your loft space.

For each Controller you have 4 available channel settings. You can programme as many Receivers on each channel as you like, but each Receiver has a maximum load of 350W/VA. This means you can attach multiple lights/lamps to each Receiver, but you must not exceed 350W/VA per Receiver. All lights connected to a channel will dim up/down together (see example below).

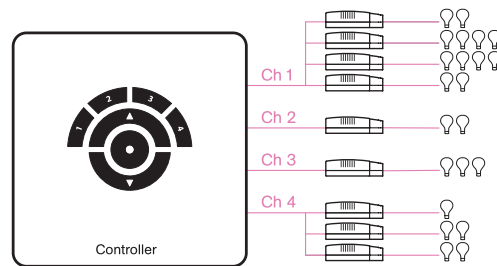

If you intend to install in more than one room read section 'Setting the Function Switches for Different Rooms' on page 27).

## 2. Surface Mounting

You can surface mount the Wall Controller using the pattress box provided. This allows you to mount the wall unit without having to make a hole in your wall. This is ideal for new installations, or where you want to mount the Controllers on a surface which you cannot drill (e.g. glass).

To fit the Wall Control module in the pattress box please complete the following process.

- Remove the front metal plate from the grid frame. This can be done by inserting a small flat blade screwdriver into either of the two slots on the side of the plastic frame and gently prising off the metal plate.
- Remove the Wall Control module from the grid plate. This is done by pinching the 2 clips at the top and bottom of the unit and pulling the module forward.
- Insert the wall module into the pattress box ensuring that the buttons are facing the correct way. The pattress and module are marked 'TOP'.
- Refit the front plate.
- To mount the pattress on the wall, peel off one side of the double sided tape provided and firmly press onto the recess on the rear of the pattress box.
- Ensure that the surface on which you intend to mount the pattress is clean dry and free from grease and debris.
- Peel off the other side of the tape and press the pattress firmly onto the wall.

- c) You will need to remove the face plate prior to installation. This can be done by inserting a small flat blade screwdriver into either of the two slots on the side of the plastic frame and gently prising off the metal plate.

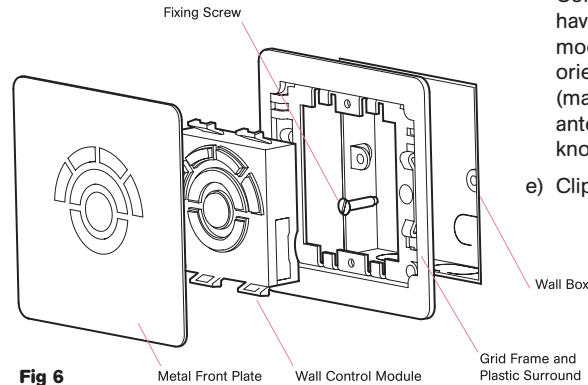

**Fig 6**

- d) Install the grid frame in the wall box using the two M3.5 screws provided. The Wall Control module comes assembled to the grid frame. This can be removed to make installation easier. To remove the Control module pinch the 2 clips at the top and bottom of the Control module and pull it forward. Once you have installed the frame you can press this module back into place. Please align the orientation of the module with the frame (marked top). To improve reception extend the antenna outside the metal wall box through a knock-out into the wall cavity.
- e) Clip the metal front plate on to the grid frame.

**Read these instructions fully before commencing work and keep them for future reference.**

**Before installing the system please check that all your lights are working correctly.**

**If you are in any doubt how to proceed, consult a qualified electrician.**

### Safety instructions

- + This product should be installed in accordance with the applicable parts of the building regulations, and the current edition of the IEE Wiring Regulations (BS 7671: Requirements for electrical installations) and appropriate statutory regulations. In the Republic of Ireland the installation must be in accordance with the ETCI National Rules for Electrical Installations – ET 101.
- + **Before commencing work, switch OFF the mains supply and remove appropriate fuse or switch off the circuit breaker.**
- + Do not install ceiling receivers on lighting circuits used to supply other products such as extractor fans and shaver socket outlets.

### UK wiring information

Note: As from 1 April 2004, new installations in the UK should be wired using the new EU harmonised colours for the supply conductors:













- + **New colours:**  
BROWN = Live      BLUE = Neutral
- + **Old colours:**  
RED = Live      BLACK = Neutral





The old colours will cease to be used from April 2006.

- + Electrical installations in bathrooms, kitchens, gardens, floor and heating systems, swimming pools, saunas and extra-low voltage lighting are classed as special installations and must be certified by an approved competent electrical contractor conforming to Part P, requirements of BS 7671:2001 and appropriate statutory regulations.

The GET Smart Wireless Lighting System is compatible with many lamp types. Please check the tables below to ensure that your lamp types are compatible. If you are using Low Voltage lighting you

will still need to use a suitable Transformer. If you are in any doubt please contact the GET Customer Helpline on 0121 565 7770.

Lamp Types Mains Voltage	Profile	Lamp Types Mains Voltage	Profile
G9		GLS BC	
Strip and Architectural		GLS ES	
PAR30		SES Candle/Round	
PAR36		SBC Candle/Round	
PAR38		GU10	
PAR20		K1 / K9 K11 / K12	

Lamp Types Low Voltage	Profile
G4	
G6.35	
MR16	
MR11	

GET-Smart WLC will <b>not</b> operate with the following type of lamps:
G23
PL E-C Pro
SLE-Pro
CFL
Linear Fluorescent
Compact Fluorescent and Low Energy
Metal Halide (all)
High Pressure Sodium Lamps
Single End High Pressure Lamps

## Installing the Controllers

Once you have finished programming the Receivers you should position the Controller(s). As the system is wireless these can be positioned anywhere in your home. You can have multiple units controlling the same lights, so you may have more than 1 Controller in a room (e.g. 1 Wall Controller and 1 Remote Controller). We suggest that you place a Controller by the door of the room so it is easy to find when you enter or exit that room.

There are 2 different types of Controller:  
Wall and Remote

Wall and Remote Controllers are programmed and operate in exactly the same way.

### Wall Controller

The Wall Controllers come complete with 2 different fixing options. Please choose the method that best suits your needs.

#### 1. Flush mount using a Grid frame (comes attached to product)

This method is used to fit the Wall Controllers into a wall box, such as the one used to house your standard light switch. This method is ideal if you are replacing an existing light switch as it will avoid any additional decorating. The unit will fit in a 16mm box without terminated conductors.

Fitting Instructions see Fig 6 for assembly order.

- Check the wall box and reposition any terminated conductors and terminal blocks to ensure that they do not interfere with the mounting of the Wall Controller.
- For installations in 1 gang 4 lug boxes the top and bottom lugs will need to be bent inwards and out of the way.

### Duplicating a Controller

You may want to duplicate the operation of a Controller. For example, you may want multiple Controllers to operate in the same room.

#### House switches

Duplicate the House switches.

#### Room switches

Duplicate the Room switches.

#### Mode settings

Master/Slave mode	Duplicate these switches
Dimmer/Scene mode	Duplicate these switches

If you wish you can use one Controller to dim the channels and one Controller to operate scenes.

To do this set the dimming/scene switches as required.

### Replacing a lost or damaged Controller

If you lose or damage a Controller, simply purchase a replacement, find the record of your switch settings on your old Controller and duplicate these on your new Controller. All the programming settings are stored in the Receivers, so the Controllers/Receivers do not need to be reprogrammed.

### Interference problems

In the unlikely event that you experience interference with another system, you will need to alter the coding on the Controller of your affected room. Simply alter the position of the House switches on this room by moving one switch to a completely different code. Please note that at least one switch needs to be in the up position.

Once you have changed these house settings you will need to reset the channels as set out in the programming section. You will also need to update all the affected controllers and rooms with these new switch settings. Please make a note of your new switch settings.



Floor Receivers are designed for use with portable, table, desk and standard lamps.

**Important Note: Do not use the Floor Receiver with lighting fittings that already incorporate a dimmer e.g. floor uplights incorporating dimmers, touch dimmers, or slide/rotary dimmers in the supply cable. Not suitable for use with lamps which have transformer plugs.**

### Safety instructions

- Unplug the lamp to be controlled by the Floor Receiver from its mains supply prior to commencing any wiring and installation work.
- The plug supplied with the Floor Receiver is fitted with a 5 Amp BS 1362 approved fuse. Ensure that an equivalent type and rating is used should the fuse require replacing.

### Plug replacement

If the plug becomes damaged and requires replacement, follow the wiring instructions supplied with the new plug.

- The Neutral (Blue) conductor must be connected to the terminal marked with the letter N.
- The Live (Brown) conductor must be connected to the terminal marked with the letter L.
- The Earth (Green/Yellow) conductor must be connected to the terminal marked with the letter E.

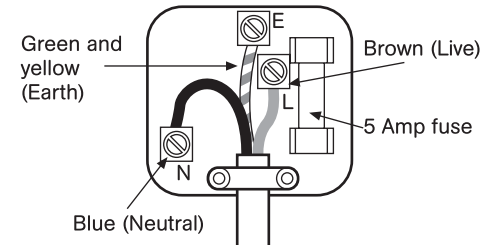

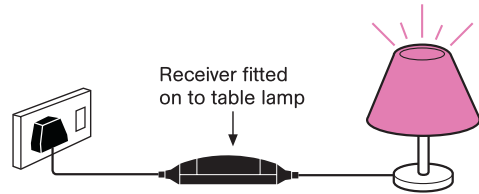

## Installation and wiring

- Remove existing mains plug from the lamp cable (not suitable with transformer type plugs).
- On the end of the Receiver without fitted cable and plug, remove the end cover by unscrewing the two screws on the underside to expose the terminals.
- Remove cable grommet and unscrew the two screws that secure the inner cable clamp.
- Fit cable grommet on to the lamp cable.
- Prepare conductor ends of existing supply cable in accordance with the recommended cable stripping lengths (see Fig 1a on page 13).

- Connect individual bared conductor ends to appropriate marked Receiver terminals as shown in Fig 1.
  - Neutral (Blue) to terminal marked N
  - Live (Brown) to terminal marked L
  - Earth (Green/Yellow) to terminal marked  $\perp$

**Note:** Some cables will not have an Earth Wire (Yellow/Green). In this case, just connect the Brown and Blue wires.

- Secure the cable grommet to the end of the Receiver moulding and ensure all bare conductor ends are fully inserted into each terminal. Check that there are no stray wire strands protruding from any of the terminals. Make sure all terminal screws are tight and secure.
- Refit cable clamp and secure over outer cord insulation by tightening the two fixing screws.
- Refit Receiver end cover and securely tighten the two fixing screws.
- Once all connections have been tightened and checked, plug into the socket and switch on.

## KEY:



- A Master Controller will control Scene 1 in up to 4 different rooms.
- In order to be able to use the Master Controller you must first have set up at least two rooms with the same house number.
- A Master Controller will only control rooms which have been set to the same house number.
- Any Controller can be turned into a Master Controller.

## Set Up

### Step 1

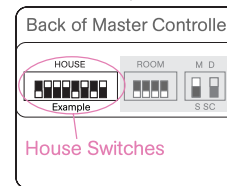

Adjust the House switches so that they match the House switches on the Controller/s within the rooms that you wish to control.

### Step 2

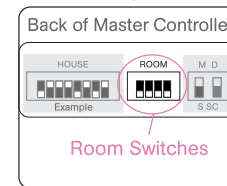

Adjust the Room switches on the Master Controller so they are all in the down (off) position.

### Step 3

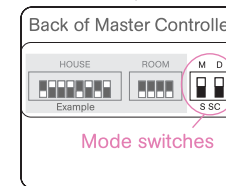

Adjust the Function switches so that the Master/Slave switch (left function switch) is set to the up position (M). The dimmer/scene switch (the right function switch) should also be set to the up position (D). **Master Mode is now set, no programming is necessary.**

## Operation



Press button 1 on the master controller to turn on scene 1 in Room 1, press button 2 to turn on scene 1 in Room 2, button 3 to turn on scene 1 in Room 3, and button 4 to turn on scene 1 in Room 4. Centre button toggles scene 1 in all Rooms on/off.





**Note:** Before commencing work, switch OFF the mains supply and remove appropriate fuse or switch OFF circuit breaker.

### Safety instructions

- Lighting circuits supplying Ceiling Receivers should always be protected by either a 5 Amp rewirable fuse or 6 Amp Miniature Circuit Breaker (MCB) located within the Consumer Unit. Under no circumstances should any protection devices with higher ratings be used.
- Ceiling Receivers should be mounted in areas that are adequately ventilated and dry.
- Ceiling Receivers are designed to be maintenance free, but should be mounted in a position where access is possible should there be a fault or re-addressing of the unit become necessary.

- In the case of transformer-fed loads for Low Voltage lighting, only use fully dimmable electronic transformers suitable for use with leading edge dimmers. If you are in any doubt contact the GET Customer Helpline on **0121 565 7770**.
- Ceiling Receivers are not designed for loop in/loop out connections. Should it be necessary to loop the supply onto further fittings then a suitable junction box should be connected in the circuit to facilitate this.
- The Ceiling Receiver is designed to be connected to the existing permanently live lighting circuit between a convenient junction box and the light fitting.
- Any existing switches currently controlling the light fitting should be disconnected and terminated. (See 'Existing Light Switches' on page 16).

Once you have installed your first room, you can add a further three rooms to your system using the same House switch setting. This will give you the opportunity to control these four rooms using a Master Controller (please see the Master Controller section of the instructions). This Controller can be added at any time and will not need any programming.

### Adding up to three additional rooms

#### House switches (rooms 2, 3 and 4)

The house switches on the additional room controllers should be set **exactly** the same as the 'Room 1 Controller'. These should be changed using the tool provided.

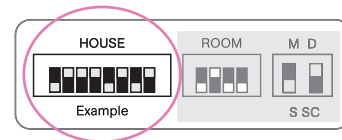

**KEY:**



**Step 1**

Mode switch in down position.

**Setting Mode Switches**  
All lights must be turned off before altering the switches.  
The far right 'Mode' switch must be in the down position (pointing towards SC).

**Step 2**

**Choosing the Scene**  
Press the button of the scene number you wish to view.

**Step 3**

**Dimming the Scene**  
Use the up and down buttons to adjust brightness of the active scene.

**Step 4**

**Changing the Scene**  
To view a different scene press another button.

**Step 5**

**Turning off Lights**  
Press centre button to turn off scene (the lights will turn off).

- For lighting circuits using ceiling roses, it is recommended that the existing wiring connections should be re-terminated using a suitable junction box. The new connections from the receiver to the ceiling rose are as shown in Fig 2 and 3 on page 17 and 18.
- For downlight installations the Ceiling Receiver is designed to pass through a 60mm (min) downlight cut-out hole.
- For Low Voltage installations the Receivers should be connected between the permanently live lighting circuit cable and Low Voltage Transformer junction box (see Fig 2 on page 17).

**Installation and wiring:**

- Before you start to install the Receivers, isolate the circuit at the fuse/MCB board.
- To wire the Ceiling Receiver, remove the module end-cover by unscrewing the screw to expose the terminal connections (located on top of the unit).
- Connect the supply Live and Neutral conductors to the Receiver terminals marked L and N SUPPLY (see Fig 3 on page 18).
- Connect the cable from the light fitting to the Receiver terminals marked LOAD  $\approx$  and N.
- For earth continuity the supply and load Earth conductors must be terminated externally using an insulated terminal block (see Fig 2 and 3 on page 17 and 18). All Earth conductors must be suitably sleeved with Green/Yellow sleeving (sleeving and terminal block supplied). To make room for this connection remove the 'knock out' on the receiver cap.

- Ensure that all bare conductor ends are fully inserted into each terminal, that all terminal screws are tight, and that the cable clamp is tightened on the outer cord insulation.
- Replace end cover and tighten fixing screws.
- Replace Main supply fuse or switch on the MCB. Turn ON the Mains power supply.
- Do not position the Receivers in the ceiling void until the set up process is complete (see page 20-23) as you will need to gain access to programme the system.
- Once you have set the channels you can reinstall your light fittings. Ensure that you turn the power OFF before carrying out this task (turning OFF the power will not affect the information you have programmed into the Receiver).
- Replace Main supply fuse or switch on the MCB. Turn ON the Mains power supply.

### Existing light switches

When installing Ceiling Receivers in existing lighting circuits, conventional light switches are not required and should be disconnected as part of the installation.

It is recommended that this is best achieved by removing the Live switch supply and return conductors from the junction box or ceiling rose as appropriate. All removed conductors should be individually terminated in insulated terminal blocks with additional PVC tape insulation applied to cover all terminal blocks. This should also be carried out at the switch end of the circuit.

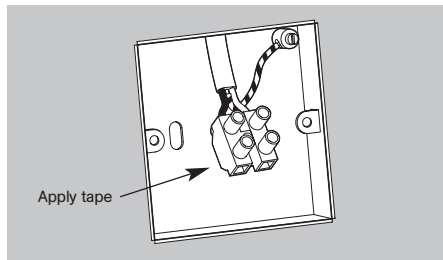

## Setting Scenes

- We recommend that you leave scene number 1 programmed so that all channels are set to full brightness (this is the default setting (for safety reasons)).
- Scene 1 also controls the default 'on' value in dimming mode.

### KEY:



#### Setting Mode Switches

All lights must be turned off before altering the Mode switches.

The far right 'Mode' switch must be in the down position (pointing towards SC).

#### Choosing Scene Number to Programme

Ensure all lights are turned off. Press and keep holding the desired scene button (lamps will raise). Whilst keeping this pressed, press and hold the up and down arrow buttons for at least five seconds until LEDs pulse – lamps will flash once and stay on.

#### Selecting Channel

Use button 1, 2, 3 or 4 to select the channel you wish to adjust. (These are the channels you created earlier). When you select a channel all the lights on that channel will flash.

#### Changing Channel Brightness

Use up and down arrow buttons to adjust brightness of the channel. (Repeat steps 3 and 4 until you have set all the channels to the desired light level for this scene).

#### Saving and Exiting

Press centre button to save and exit. You have now set your first scene. See 'Operating a Scene' to view this scene. (Repeat steps 2-5 until desired number of scenes are set). You can set up to four scenes.

NB. If you don't operate the Controller for two minutes during the programming process the Controller will leave programming mode.

**KEY:**



**Step 1**

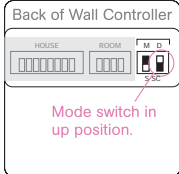

**Selecting Dimming Mode**

Ensure the right 'Mode' switch is in the up position (pointing towards D).

**Step 2**



**Choosing Channel to Dim**

Press button 1, 2, 3 or 4 to select the channel you wish to control. Once you press the button all the lights set on that channel will raise in brightness.

**Step 3**

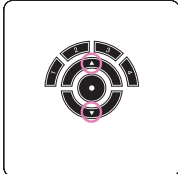

**Dimming the Channel**

Use the up and down arrows to set the output to the desired lighting level, this will now remain as set until switched off.

**Step 4**

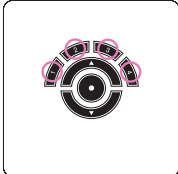

**Selecting a Different Channel to Dim**

Press button 1, 2, 3 or 4 to switch to a different channel.

**Step 5**



**Turning off Lights**

Press centre button to turn off all channels. Alternatively, pressing the button of an active channel will turn off that channel.

NB. This is not a scene setting mode and preset light levels will not be saved.

**Low Voltage installation example – Fig 2**

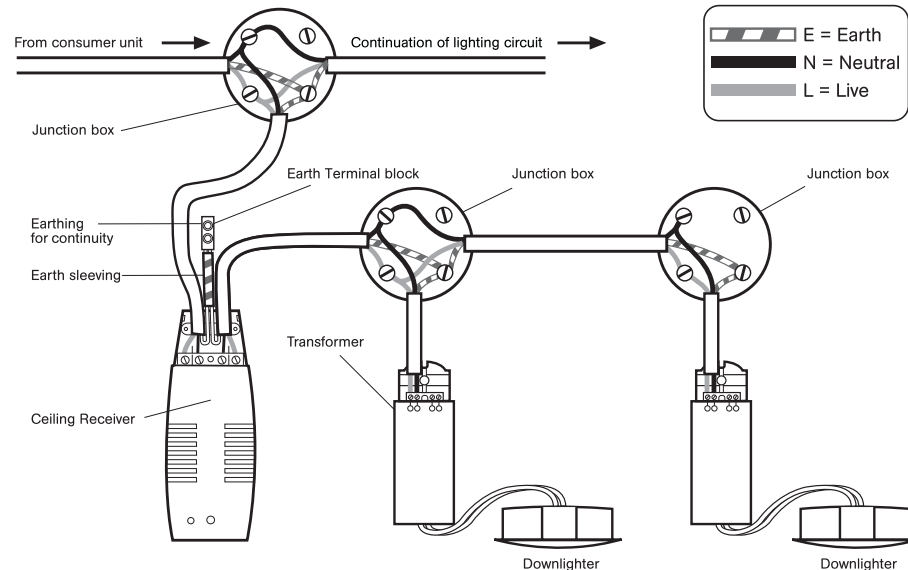

### Mains Voltage installation example – Fig 3

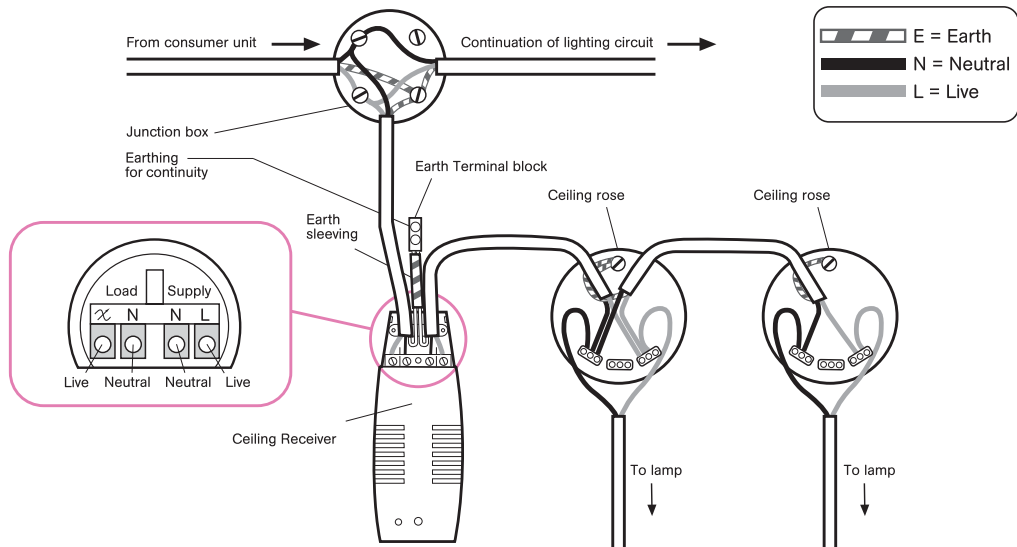

### Setting the Channels

#### KEY:



- Should you need to change any of the Function switches use the tool provided.
- These instructions are the same for both Floor and Ceiling Receivers.

#### Step 1

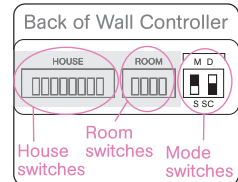

Please complete the boxes below with the factory preset switch positions (house and room only).



The 'Mode' switches should be set as above. Please change if necessary.

(If you are installing multiple systems or additional transmitter units in your house, please read 'Setting the Function Switches' section on page 27 and 28).

#### Step 2



Press and hold the button on the selected Floor/Ceiling Receiver for at least five seconds – The connected lights will flash once and the LED will start to pulse.

#### Step 3

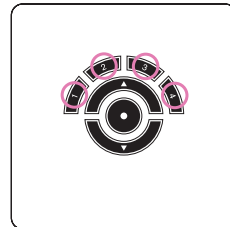

Press button 1, 2, 3 or 4 to set Floor/Ceiling Receiver and connected lights to that channel. The lights will flash once and then raise. This indicates that the channel has now been set.

#### Step 4

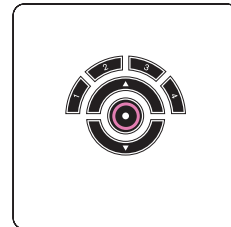

Press the centre button to exit programming mode. The lights will dim.

**Repeat steps 2-4 until all the Floor/Ceiling Receivers are set.**

NB: The LEDs on the Floor/Ceiling Receivers will flash when they detect a signal from any Controller whether they have been assigned or not. This will not effect their operation.

For optimum range of the Wall Controller ensure that the wire aerial is fully extended within the mounted enclosure.

**Fig 5:**  
**Remote Controller –**  
Inside the clam shell of the Remote Controller:

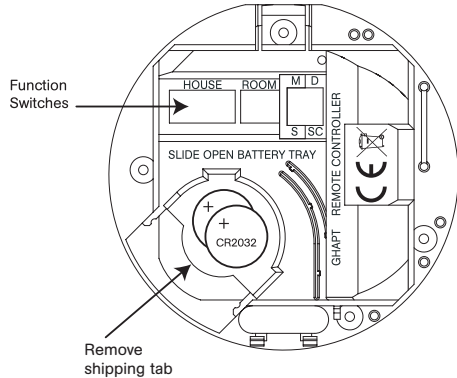

When you have gained access to the Function switches you will see that they are arranged in 3 groups. The first two groups of switches (house and room) come factory set, you will not need to alter these when installing your first room. These are used for installing multiple rooms into your house. You will however need to make a note of these for future reference.

The third group of switches are used to select the control functions ie- SC = scene setting. These are covered on the following pages.

All outdoor garden installations must be installed in accordance with IEE Regulations for Special Installation Requirements. A 30mA RCD (Residual Current Device) should always be placed between indoor and outdoor electrical circuits, including the initial connection to an outdoor transformer used for Low Voltage lighting.

Please note that both the Floor Receiver and Ceiling Receivers do not have an appropriate weatherproof IP rating to be directly located outside. They should be either wired such that they are located indoors or alternatively if required to be located outside, housed in a suitable weatherproof enclosure of at least IP56 rating (Such as the GET GE157S/GE197S). Both Floor and Ceiling Receivers can be used to control a variety of outdoor Low Voltage and Mains garden lighting applications.

For Low Voltage garden lights using Low Voltage transformers located indoors, connect the transformer supply cable to the Floor Receiver output terminals. The Floor Receiver can then be plugged directly into the mains supply. Ensure the Floor Receiver is located indoors.

Before you can start the set up process you will need to remove the battery shipping tabs from the Controllers. These are located in the battery draws of both types of Controllers. For details of how to access this battery draws please (see pages 35 and 37).

Once you have installed your Receivers you need to 'assign' each of these to a channel on a Controller. This process is known as 'Setting the Channels'. You will need to set the channels whether you intend to use the Controller in Scene mode or Dimming mode.

Each Controller has 4 channels. A channel functions just like a traditional dimmer, allowing you to alter the brightness of any lights attached to it.

- + A Receiver can be set to any one of these 4 channels.
- + Any lights attached to a channel will dim together.

- + Multiple lights can be attached to each Receiver (up to the 350W/VA limit).
- + Multiple Receivers can be set to each channel (therefore there is no limit to the amount of lights you can attach to a channel).
- + You do not have to use all the channels if you do not want to.

### Dimming Mode

Once you have set the channels you can dim these up and down in much the same way as a traditional dimmer (wirelessly). This mode of operation is called Dimming Mode.

### Scene Mode

Scene Mode allows you to set up to 4 different lighting scenes. A scene is created by adjusting the channels you have just created into a desired lighting pattern or scene. You then set this Scene into the memory. Once set this scene can be recalled at the touch of a button. You have the option to create 4 scenes per Controller.

The instructions now explain how to program the channels in one room (Controller) and then how to dim them. Once the channels have been set you can then set and operate scenes if you wish – you may switch between dimming mode and scene mode at any time.

Once your first Room (Controller) is working correctly read the section of the instructions called 'Setting Function Switches for Different Rooms'. This section will explain the process of setting any additional rooms, it will then explain how to control them all with a Master Controller. You will require a controller for each additional Room.

Before you go any further you will need to gain access to the Function switches on your Controller. These switches can be found on the back of either Controller (see Fig 4 and 5).

**Fig 4:**  
**Wall Controller – The back of the Wall Controller:**

