

FLOODLIGHT TRANSMITTER

Cat No's.
TLTX150B
TLTX500B



INSTALLATION & OPERATING
INSTRUCTIONS

Introduction

The TLTX150B/500B Floodlight Transmitter is part of the Timeguard range of PIR products which communicate by radio frequency (r.f.) signals. This enables substantial amounts of wiring to be eliminated which is particularly useful in long wiring runs and coverage of outbuildings.

It is a combined PIR detector floodlight and r.f. transmitter. It detects moving body heat and turns lighting on and transmits (sends) a signal to receivers in the system that have been programmed to respond to its coded signal causing their lights to turn on.

In the following instructions products with catalogue numbers including TX (ones that send information about PIR detection) are referred to as Tx units and products with catalogue numbers including RX (ones that receive information about PIR detection) are referred to as Rx units.

A Top View

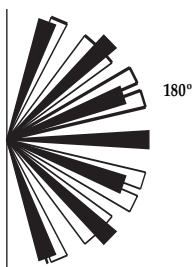

Side View



B

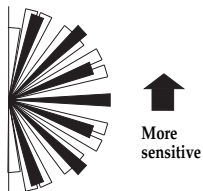
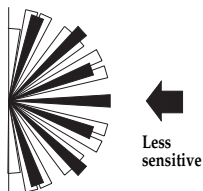

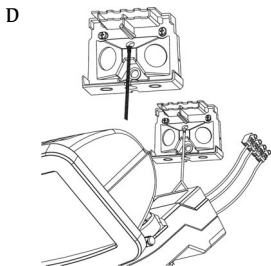
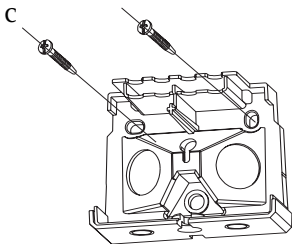

Parts included

- Luminaire and PIR Detector/transmitter unit.
- Instruction manual. Please keep safe for future reference.
- Accessory Pack.
- Tungsten halogen bulb.

Tools and parts needed

- Electric/hand-held drill & bits.
- Terminal or Electricians screwdriver.
- Large slotted/philips screwdriver.
- Wire cutters.

Unit is for outdoor use only. Unit must be mounted on a non-flammable surface as a fixed luminaire, and is not suitable for portable use.

The unit can get very hot during use. Ensure the unit has cooled before handling.

Ensure adequate ventilation space is allowed between the unit and any object above, in front or to either side of the unit. Suggested space is 0.5m above, 0.3m to either side & 1.0m in front.

If in any doubt, consult a qualified electrician.

Selecting a location

For optimum performance, mount the Tx unit at 2.5m (8ft) high. The sensor can be pointed in any direction as long as it is within 100m of the receivers it is to be used with. The detector can detect motion up to 12m within a 180 degree radius.

Avoid areas where pets or traffic may trigger the sensor. Avoid mounting where the detector aims at objects that change temperature rapidly, such as central heating vents, air conditioners or waving branches. Avoid reflective surfaces like conservatories or pools of water.

The detector moves up or down, left or right to change the coverage area.

Keep in mind the sensor is most sensitive to movement across its field of vision.

The motion detector has a number of detection zones, at various vertical and horizontal angles as shown (see diagram A). A moving human body needs to cross/enter one of these zones to activate the detector. The best all-round coverage is achieved with the unit mounted at the optimum height of 2.5m. Careful positioning of the detector will be required to ensure optimum performance. See diagram A detailing detection range and direction.

The detector is more sensitive to movement **ACROSS** its field of vision than to movement directly **TOWARDS** it (see diagram B). Therefore position the unit so that the sensor looks **ACROSS** the likely approach path.

Avoid positioning the unit where there are any sources of heat in the detection area (extractor fans, tumble dryer exhausts etc.).

Reflective surfaces (ie pools of water or white-painted walls) and overhanging branches may cause false activation under extreme conditions.

During extreme weather conditions the motion sensor may exhibit unusual behaviour. This does not indicate a fault with the sensor. Once normal weather conditions return, the unit will resume normal operation.

When siting Rx units that will need to work with the TLTX150B/500B the signal reception range will be less than 100m if walls or chain link fences come between the Tx and Rx units - if there is any doubt whether communication will take place make temporary installations before programming.

Installation

IMPORTANT

Switch off the electricity at the fuse box by removing the relevant fuse or switching off the circuit breaker before proceeding with the installation.

Remove the wall plate from the floodlight by unscrewing the facing screw (Fig. F). this screw is captive, Do Not remove completely from the floodlight.

Mark position of the fixing holes. (Fig C)

Drill the holes. Insert the wall plugs into the holes.

PASS THE CABLE THROUGH THE WALL BRACKET BEFORE SECURING WALL BRACKET TO THE WALL.

Pierce the grommet and pass the cable through the wall bracket.

Allow approximately 100mm of cable to pass through the grommet. (A template for this wire length is provided on page 12 of this manual).

Fit grommet into its location hole ensuring a good seal.

Fix the mounting plate to the wall. Take care not to overtighten the screws to prevent damage to the mounting plate. If using a power screwdriver, use the lowest torque setting.

Connection

This unit is supplied with a hanging attachment (tether) to aid installation.

If it is not required, simply remove from the unit and discard.

Place the round end of the tether into the keyhole location on the wall bracket.

Ensure the tether is securely located in the slot before releasing the weight of the unit.

The unit can now be suspended below the wall bracket. (Fig D)

Connect the cable to the terminal block as follows (see connection diagram):

NEUTRAL (Blue) N

EARTH (Green/Yellow) 

LIVE (Brown) L

Ensure the connectors are secure.

Place terminal block onto its securing pillar on the wall bracket (Fig E)

Remove and discard the tether.

Fit floodlight to wall bracket and secure by fixing screw (Fig F)

Connection Diagram

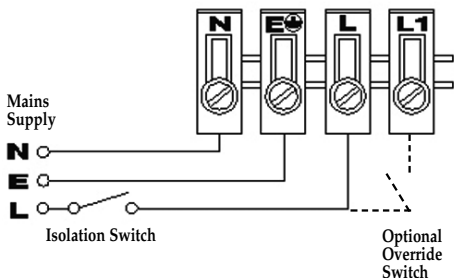

The diagram below also shows the required connections for the addition of slave luminaires.

When adding these, be sure not to exceed the maximum switchable load (see Technical Specifications).

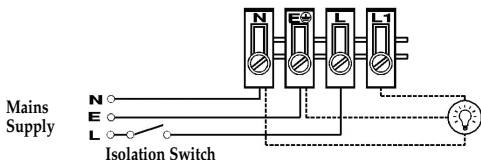

Setting up

Walk Test Procedure

The detector will rotate from left to right, and tilt forward or backward. Adjust the sensor to point in the required direction. (note diagram B)

The unit can be set up in daylight or at night.

Set the Dusk adjustment knob to "Sun" position and the TIME setting to MINIMUM

Turn the power to the unit on. The lamp will illuminate for approximately 30 seconds. This indicates the unit is wired correctly.

After approximately 30 seconds the light will turn off.

The unit is now in Test Mode. The LEDs will scroll from left to right, and "blink" on and off very fast on detection of movement and transmission to the Rx unit.

If the detection area is too small for your requirements, try angling the sensor head up. Angling the head downwards will reduce the detection area should a smaller range be required.

The TIME setting controls how long the unit remains illuminated following activation and after all motion ceases.

(See diagram G. the time adjustment knob is indicated by the "Clock" symbol).

The minimum time (fully anti-clockwise) is approx. 5 seconds, whilst the maximum time (fully clockwise) is approx. 5 minutes. Set the control to the desired setting between these limits.

The DUSK control determines the level of darkness required for the unit to start operating. The setting is best achieved by the procedure overleaf:

(See diagram G. the Dusk adjustment knob is indicated by the "Moon" and "Sun symbols).

Set the DUSK control knob fully anti clockwise.

Wait until darkness falls.

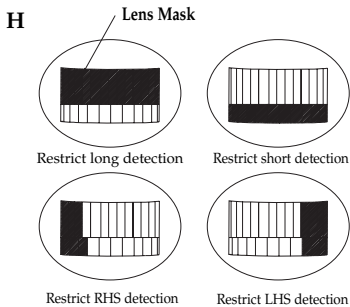
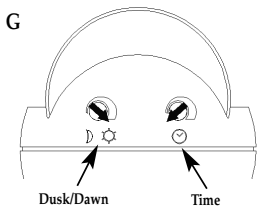
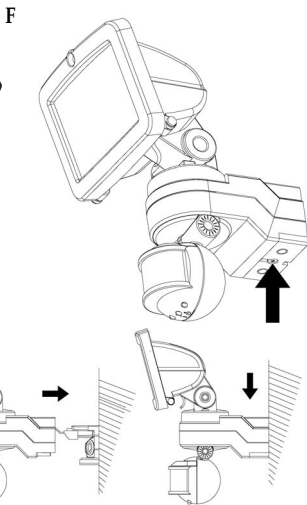
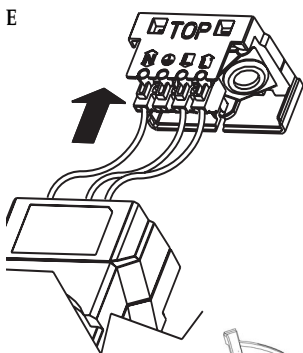

When the ambient light level reaches the level of darkness at which you wish the lamp to become operative (i.e.: at dusk) SLOWLY rotate the control in a clockwise direction until a point is reached where the lamp illuminates. Leave the control set at this point. At this position the unit should become operative at approximately the same level of darkness each evening. Observe the operation of the unit. If the unit is starting to operate too early (i.e.: when it is quite light) adjust the control slightly anti-clockwise. If the unit starts to operate too late (i.e.: when it is very dark). Adjust the control slightly clockwise.

Continue to adjust until the unit operates as desired. The LED's will scroll from left to right, day and night; indicating the unit is in Detection Mode.

The LED's will extinguish when the PIR activates the light for as long as the lamp is illuminated.

Masking the Sensor Lens

To restrict the sensor coverage, preventing detection in unwanted areas, mask the sensor lens using the masks provided in the accessory pack (see diagram H). For your information, the top section of the lens covers long range detection, the bottom covers short range. Similarly the left and right lens sections cover the left and right detection areas respectively.

Manual Override Mode - Single LED Illuminated

The light can be switched on for longer time periods by use of the Manual Override Mode. This can be activated at night by using the internal wall switch or circuit breaker.

Switch the internal wall switch/circuit breaker once (off/on) within 2 seconds. The unit will now illuminate continuously it is switched back into Detection Mode.

Programming

To be operated by the Timeguard Wireless Transmitters, the Timeguard Wireless Receivers must learn the Transmitters unique code. This programming is achieved automatically by the following procedure.

1. Press the Rx unit PROGRAM button for 1 to 2 seconds while the Rx unit is powered. Be careful not to press for much longer than 2 seconds or you may erase all existing memorised codes. The light will go ON indicating it is in PROGRAM MODE and will remain on up to 5 minutes. (If programming a Chime Receiver it will make a "beep" and the LED will flash indicating it is program mode)

2. Activate the Tx units PIR detector to send a signal to the Rx unit by walking into its detection zone.

The Floodlight turns on and the Tx units LED flashes red indicating motion has been detected and a signal has been transmitted. The Tx unit will to send its coded signal to the Rx unit and its light will go off. (if using a Chime receiver a "chirp" will sound indicating it has been coded with the Tx units signal).

3. The Rx unit has acknowledged the Tx units signal by turning the lights OFF. The Rx is now programmed to respond to the Tx unit. No other Tx unit can activate this RX unit unless it is programmed to do so.

4. If the lights did not go OFF or the Chime did not "beep" the Rx is not picking up a signal.

5. Further Rx units may now be introduced to this Tx unit if required.

Check the radio signal path between the Sensor and Receiver for any metal obstructions (walls, support beams, chain link fences etc). These can interfere with signal transmission.

PLEASE NOTE:- PLEASE SEE THE SEPARATE INSTRUCTION MANUALS FOR THE RECEIVER PRODUCTS TO UNDERSTAND HOW TO PROGRAM AND ADJUST THAT SPECIFIC Rx UNIT.

Troubleshooting guide

Problem

- Lamp stays ON all the time at night.

Solution

The unit may be suffering from false activation. Cover the sensor lens completely with a thick cloth. This will prevent the sensor from "seeing" anything. If the unit now switches off after the set time duration and does not re-activate, this indicates that the problem was caused by false activation. The problem may be solved by slightly adjusting the direction/angle of the sensor head (Refer to Setting Up) for more details.

- PIR keeps activating for no reason/at random.

You may not be allowing the unit time to complete it's warm-up period. Stand well out of the detection range and wait (the warm-up period should never exceed 1½ minutes). Occasionally, winds may activate the sensor. Sometimes passages between buildings etc. can cause a "wind tunnel" effect.

Ensure the unit is not positioned so as to allow detection of cars/people using public thoroughfares adjacent to your property.

- PIR sensor will not operate at all.

Check that the power is switched ON at the isolation switch.

Turn OFF the power to the unit and check the wiring connections as per the diagram (see Installation).

Ensure no connections are loose.

Check the lamp. If the lamp has failed, replace. Ensure that the lamp is seated correctly in the lampholder.

- The PIR sensor will not operate at night.

The level of ambient light in the area may be too bright to allow operation at the current DUSK setting. During the hours of darkness, adjust the DUSK control slowly clockwise until the lamp illuminates. Refer to Setting Up for more details.

- **Unit activates during the daytime** The level of ambient light in the area may be too dark for the current DUSK setting. During daylight, adjust the DUSK control slightly anti-clockwise. When the lamp load extinguishes, enter the detection area. If the PIR still activates, the setting is still too high. Repeat the above procedure until the PIR does not activate when you enter the detection area. Refer to Setting Up for more details.
- **PIR coverage is poor/sporadic** Unit may be poorly located. See Selecting a location and re-locate the unit.
- **Detection range varies from day to day** PIR sensors are influenced by climatic conditions. The colder the ambient temperature, the more effective the sensor will be. You may need to make seasonal adjustments to the sensor head position to ensure trouble-free operation all year round.

Technical specifications

Detection Range:	Up to 12 metres
Detection Angle:	180°
Transmission Range:	Up to 100m (varies with surrounding structures)
Power Supply:	230 V AC ~ 50Hz
Maximum Switchable Load:	2000W (4 x 500W Tungsten Halogen)
Lamp Type:	TLTX500B: 230V Linear Tungsten Halogen 500W max (R7S cap) TLTX150B: 230V Linear Tungsten Halogen 150W max (R7S cap)
Time On Adjustment:	5 seconds - 5 minutes
Dusk Level Adjustment:	Day & night or night only operation
Environmental Protection:	IP44 (suitable for outdoor use)
Transmission Range:	Upto 100mm (varies with surrounding structures)
Conforms to Directives:	73/23/EEC and 89/336/EEC

Incoming Wire Template

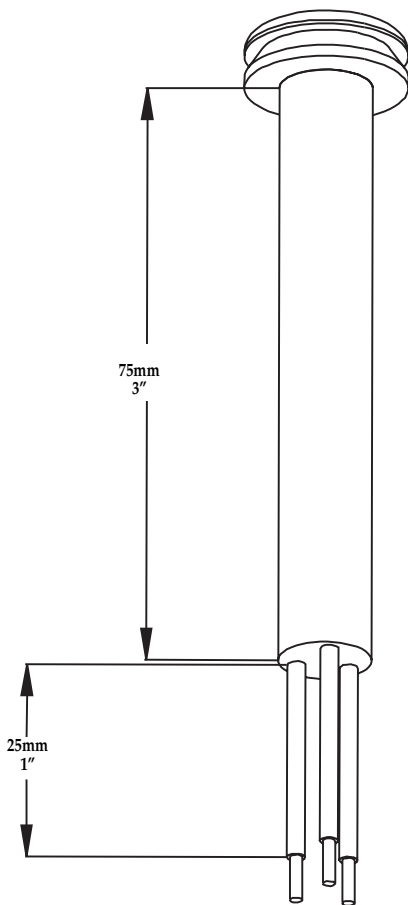

Use this template to estimate incoming cable length

5 Year Guarantee

In the unlikely event of this product becoming faulty due to defective material or manufacture within 5 years of the date of purchase, please return it to your supplier in the first year with proof of purchase and it will be replaced free of charge.

For years 2 to 5 or any difficulty in the first year telephone the helpline on 020 8450 0515.



HELPLINE
020-8450-0515



For a product brochure please contact:

Timeguard Ltd.

Victory Park, 400 Edgware Road,
London NW2 6ND

020-8452-1112

or email csc@timeguard.com